

Renoplast SMART MINI

SMART MINI PEDESTALS

SMART MINI pedestals are used to support porcelain, ceramic, natural stone or concrete pavers.

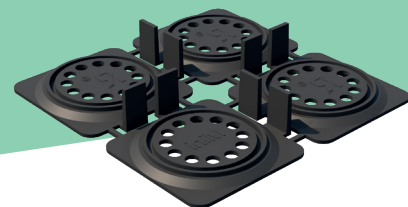

KEY FEATURES

- quick and simple to install without special tools
- modular construction - can be divided into two or four equal pieces for higher material use efficiency
- 0.5 mm, 1.0 mm, 2.0 mm, 3.0 mm levelling discs to accommodate small level differences
- can be stacked to extend height

TECHNICAL DATA

BODY	polypropylene
HEIGHT	5 mm
PAVER SPACING:	2 mm

INSTALLATION TOOLS

You will need the following tools: folding ruler, knife, spirit level, tile suction cup.

AUXILIARY COMPONENTS



0.5 MM
LEVELLING DISC



1.0 MM
LEVELLING DISC



2.0 MM
LEVELLING DISC



3.0 MM
LEVELLING DISC

BASE

Cement screed, concrete or any other sufficiently rigid and strong floor base material.

INSTALLATION

SMART pedestals are placed on the waterproof barrier. Follow the installation guide available at: <https://www.renoplast.pl/download>.

SEE PRODUCT →



Renoplast

SMART MINI

SMART MINI PEDESTALS

SMART MINI pedestals are used to support porcelain, ceramic, natural stone or concrete pavers.

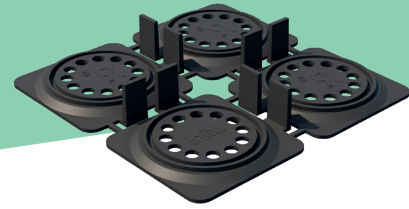

INSTALLATION GUIDELINES

Before installation read the product brochures or any other relevant guidelines relating to pedestal flooring installation, paying particular attention to support spacing requirements.

MAINTENANCE GUIDELINES

SMART MINI pedestals are suitable for balcony, terrace, patio floors and other areas with max. specified live load of 3,5 kN/m².

DIMENSIONS

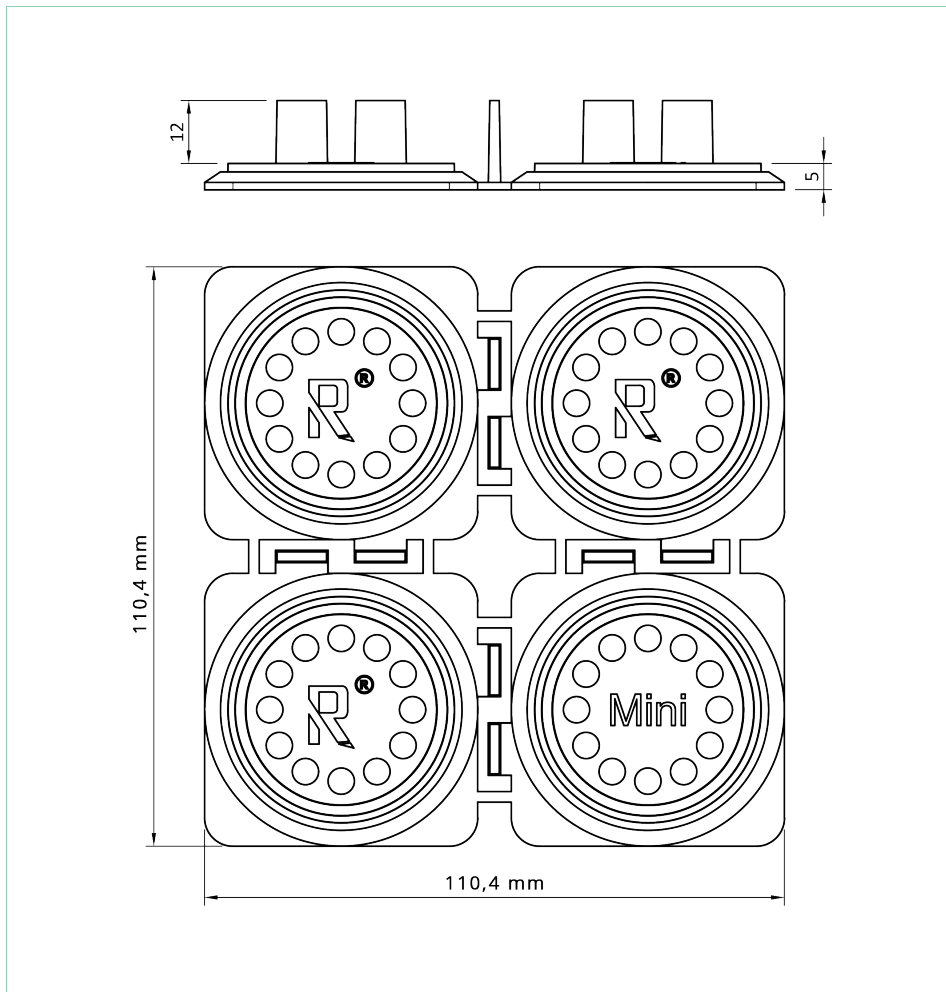

Renoplast

SMART MINI

SMART MINI PEDESTALS

SMART MINI pedestals are used to support porcelain, ceramic, natural stone or concrete pavers.

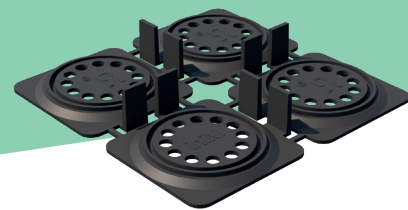

INSTALLATION EXAMPLE

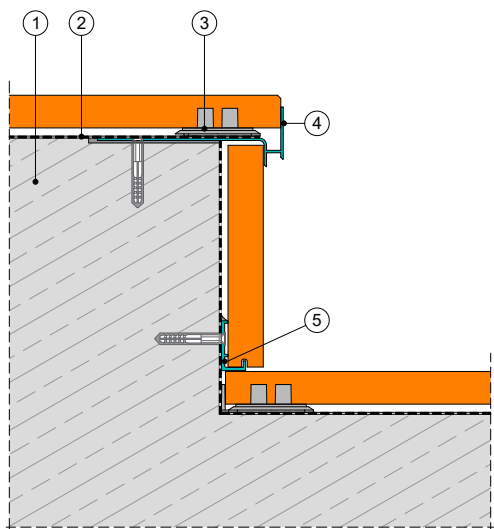

1. Concrete stair core
2. Waterproof barrier (e.g., RENOPLAST EPDM membrane)
3. SMART MINI pedestal
4. SW stair drip edge
5. SWD concealed bottom restraint bracket

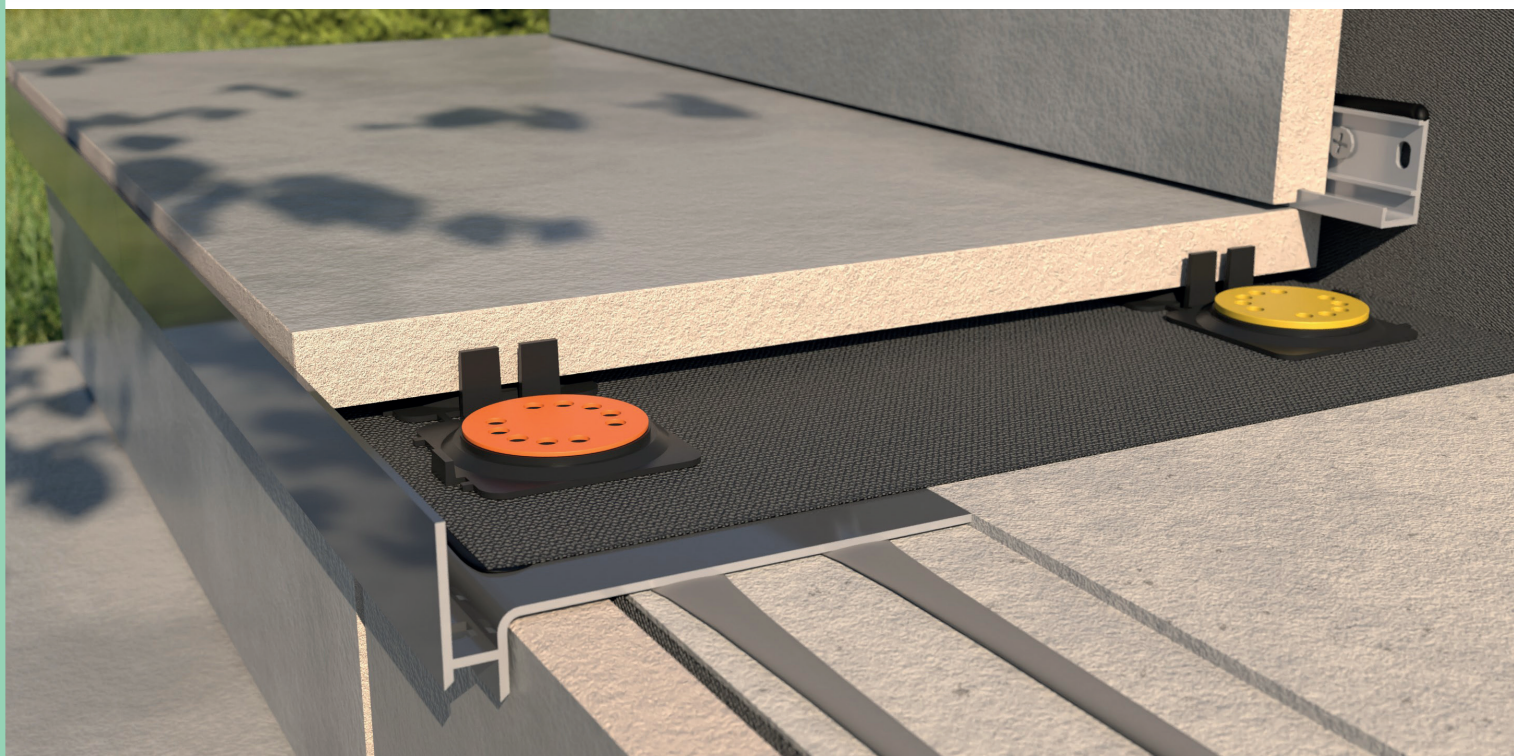

Notes:

Edition: 6.05.2026. This product brochure supersedes all previous editions. It gives recommendations for standard application conditions only, and thus shall not be used in place of installation drawings. Suitability of our products for particular conditions should be verified by the contractor. The actual product specifications may vary slightly due to allowable process or tool dimension changes. Any materials used in combination with Renoplast products must be obtained from reputable sources. Our liability for any omissions or inaccuracies of the data given in this brochure is limited to gross disinformation and/or negligence.

Renoplast

RENOPLAST Sp. z o.o.
phone: +48 697 635 580
office@renoplast.pl
www.renoplast.pl/en

