

Renoplast K20R

DRIP EDGE

K20R drip edge is part of SIMPLE K20R system used with pebblestone flooring systems.
K20R drip edges are compatible with Renoplast R50 gutter system.

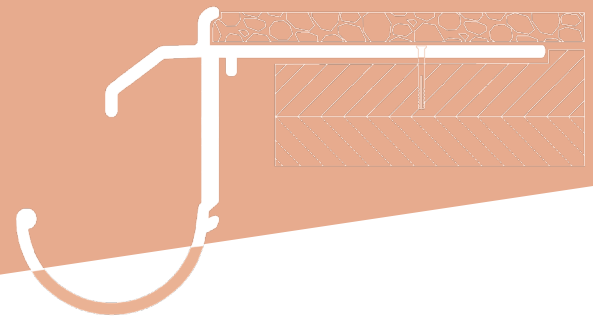

KEY FEATURES

- cost-effective profile, carefully shaped to ensure efficient drainage of water from terraces, patios and balconies
- watertight barrier at eaves line
- long-term durability and full corrosion resistance
- designed to allow attachment of Renoplast R50 gutter

TECHNICAL DATA

BODY	AW 6060 aluminium alloy
WEIGHT	approx. 850 g/m (linear meter)
COATING SYSTEM	0.6 - 1.2 g/m ² conversion coating, and min. 60 µm polyester powder coating

INSTALLATION TOOLS

You will need the following tools: folding ruler, spirit level, knife, electric drill, hand-held mixer, steel plastering trowel, string line, pencil, spatula, metal handsaw or circular saw. Circular saw should be equipped with an aluminium cutting blade to cut without damaging the coating.

AUXILIARY COMPONENTS

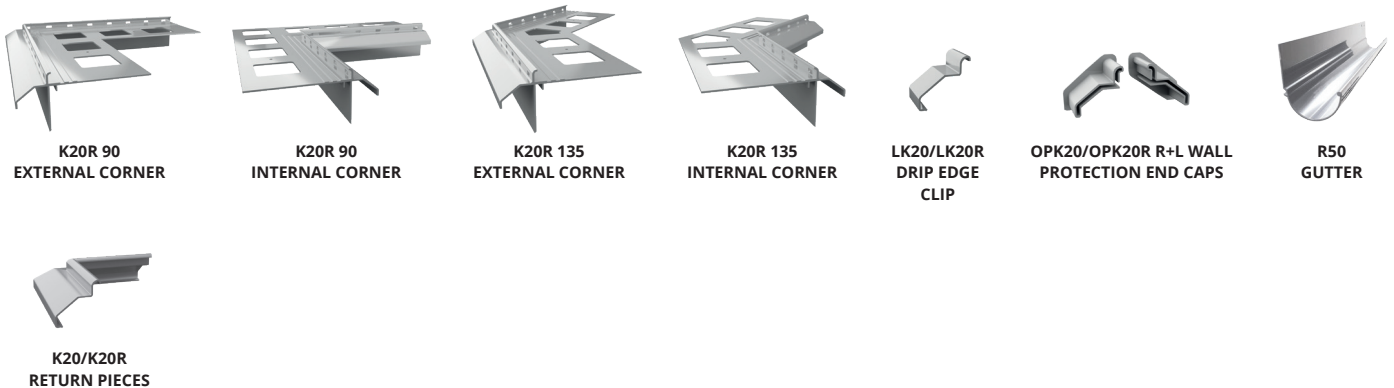

BASE

The base must be sound, level and clean. Screeds should be of min. C20 strength and should cure for 28 days. A recess, 3mm deep by 80 mm wide, should be formed around the floor perimeter to allow setting the drip edge flush with the screed top surface. This recess may be blocked out with blockout strip (supplied on request) in the case of new screed layers. In existing screeds the recess should be milled to the required depth and width (80 mm by 3 mm).

AMBIENT CONDITIONS DURING INSTALLATION

Ambient conditions should be as typically required for waterproofing and installation work.

Renoplast K20R

DRIP EDGE

K20R drip edge is part of SIMPLE K20R system used with pebblestone flooring systems.
K20R drip edges are compatible with Renoplast R50 gutter system.

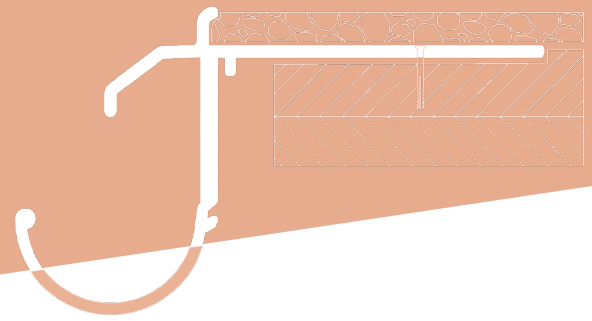

COLOURS

Standard colours: RAL 7037 dusty grey, RAL 7024 graphite grey, RAL 8019 grey brown. Other colours from RAL Classic chart are available on request.

INSTALLATION

Drip edges should be set on sealing slurry and secured in place with plastic plugs. Follow the installation guide available at: <https://www.renoplast.pl/download>.

SEE PRODUCT →



INSTALLATION GUIDELINES

Protect the paint coat from damage during installation. Reject any damaged components. Any dirt should be removed from the surfaces using water and non-abrasive cloth. Wet materials, such as sealing slurry or tile adhesive should be removed from the outer surfaces before drying. The manufacturer shall not be liable for any damage resulting from product misuse or using inadequate auxiliary materials or tools. All work must be in compliance with construction plans, product data sheet, relevant standards, good construction practice and safety requirements.

MAINTENANCE GUIDELINES

During use clean the trims at least twice a year. For cleaning use clean water and non-abrasive cloth. Do not use highly acidic or highly alkaline cleaners or surfactants which may react with aluminium. Do not use organic solvents containing esters, ketones, aromatic compounds, glycol esters, chlorinated hydrocarbons, etc. After cleaning rinse the surfaces with cold clean water. Do not use salt or other de-icing chemicals near the trims. We recommend to check the condition of the relevant terrace, patio and balcony components every six months. Immediately remove any discovered defects.

DIMENSIONS

CROSS-SECTIONS:

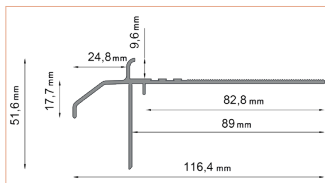

K20R DRIP EDGE

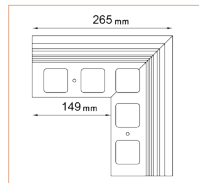

K20R 90
EXTERNAL CORNER

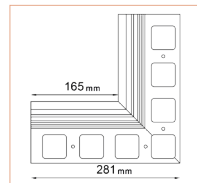

K20R 90
INTERNAL CORNER

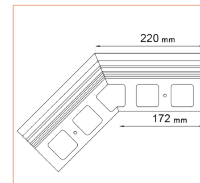

K20R 135
EXTERNAL CORNER

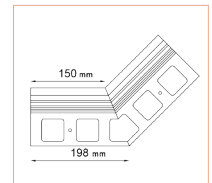

K20R 135
INTERNAL CORNER

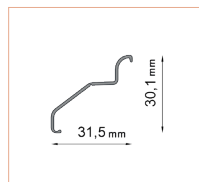

LK20/LK20R
DRIP EDGE CLIP

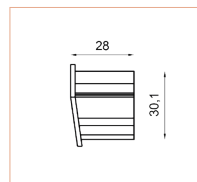

OPK20/OPK20R R+L WALL
PROTECTION END CAPS

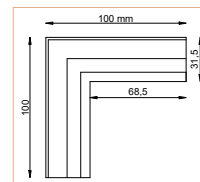

K20/K20R
RETURN PIECES

Renoplast K20R

DRIP EDGE

K20R drip edge is part of SIMPLE K20R system used with pebblestone flooring systems.

K20R drip edges are compatible with Renoplast R50 gutter system.

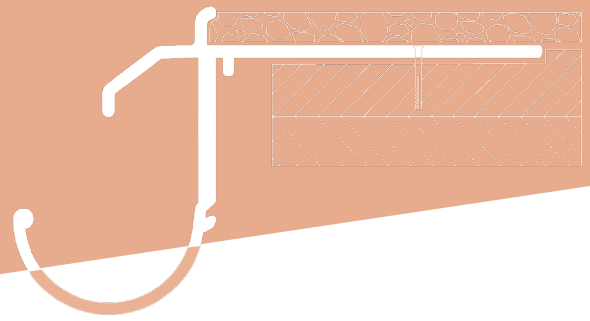

INSTALLATION EXAMPLE

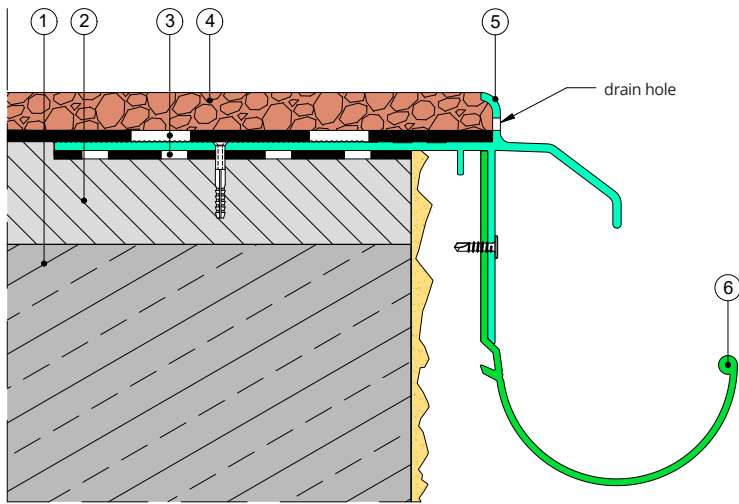

1. Structural slab
2. 1,5-2% sloping layer
3. Waterproof barrier as recommended by the resin manufacturer
4. Pebblestone flooring
5. K20R drip edge
6. R50 gutter

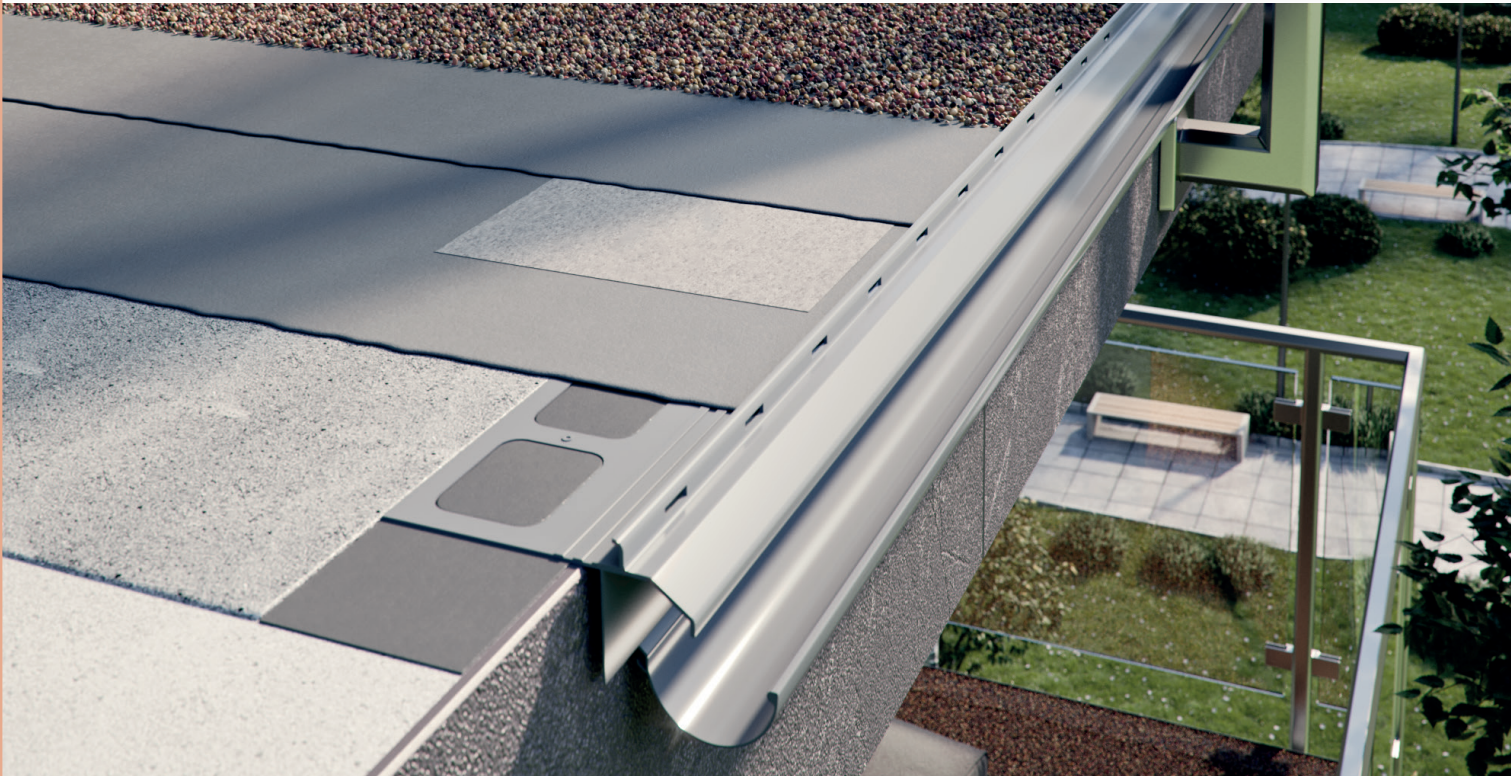

Notes:

Edition: 6.05.2026. This product brochure supersedes all previous editions. It gives recommendations for standard application conditions only, and thus shall not be used in place of installation drawings. Suitability of our products for particular conditions should be verified by the contractor. The actual product specifications may vary slightly due to allowable process or tool dimension changes. Any materials used in combination with Renoplast products must be obtained from reputable sources. Our liability for any omissions or inaccuracies of the data given in this brochure is limited to gross disinformation and/ or negligence.

Renoplast

RENOPLAST Sp. z o.o.
phone: +48 697 635 580
office@renoplast.pl
www.renoplast.pl/en

