

# Renoplast A100

## PARAPET EDGE TRIM

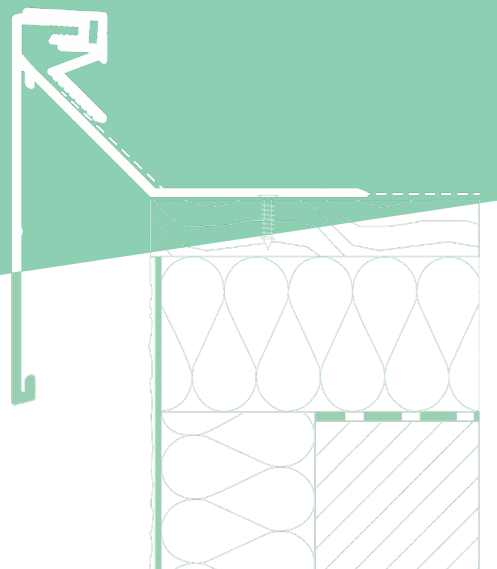

### KEY FEATURES

- easy and quick installation
- neat, durable, weather resistant
- conversion coating for higher corrosion resistance supplied as a
- a supplied as a kit including clips and corners
- compatible with EPDM, PVC, TPO, FPO, EBC roofing
- membranes adjustable clamping pressure

### TECHNICAL DATA

<b>BODY</b>	aluminium alloy
<b>WEIGHT</b>	A100 approx. 0,98 kg/m (linear meter), A20 approx. 0,29 kg/m (linear meter)
<b>COATING SYSTEM</b>	0.6 - 1.2 g/m <sup>2</sup> conversion coating, and min. 60 µm polyester powder coating

### INSTALLATION TOOLS

You will need the following tools: folding ruler, spirit level, string line (monofilament or rope), aluminium cutting saw.

### PARAPET EDGING TRIM KIT



A100  
PARAPET EDGE TRIM



A20  
TERMINATION BAR



A100 PARAPET  
TRIM CLIP



A100 90 PARAPET TRIM  
EXTERNAL CORNER



A100 90 PARAPET TRIM  
INTERNAL CORNER

### COLOURS

Standard colours: RAL 9005 black. Other colours from RAL Classic chart are available on request.

### BASE

The base must be even, without any traces of biological or chemical corrosion, sound, made of cured concrete, seasoned wood or wood-based materials.

# Renoplast A100

## PARAPET EDGE TRIM

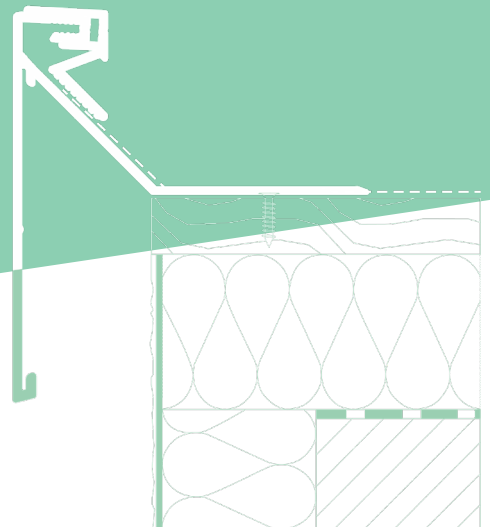

### INSTALLATION

A100 trims are mechanically fixed to base with screws or plastic plugs, as appropriate. Construction adhesive may also be applied to improve bonding strength.



SEE PRODUCT

### INSTALLATION GUIDELINES

The manufacturer shall not be liable for any damage resulting from product misuse or using inadequate auxiliary materials or tools. All work must be in compliance with construction plans, product data sheet, relevant standards, good construction practice and safety requirements.

### DIMENSIONS

#### CROSS-SECTIONS:

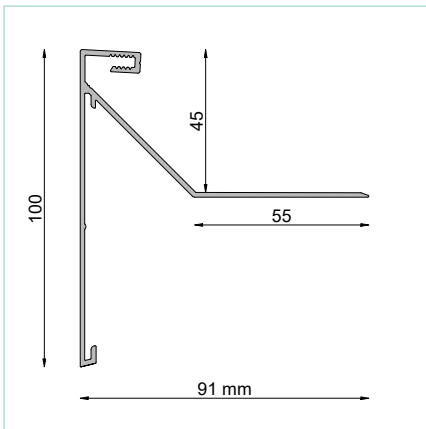

A100 PARAPET EDGE TRIM

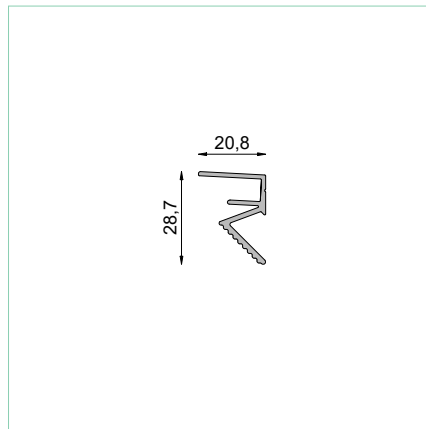

A20 TERMINATION BAR

#### VIEWS:

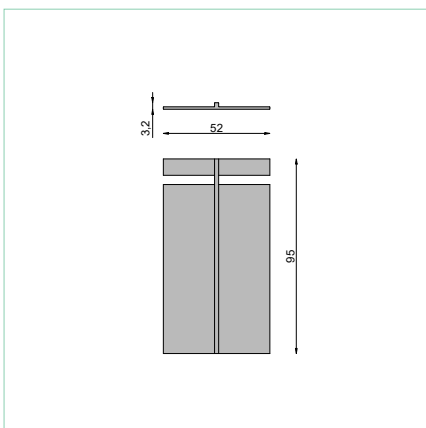

A100 PARAPET TRIM CLIP

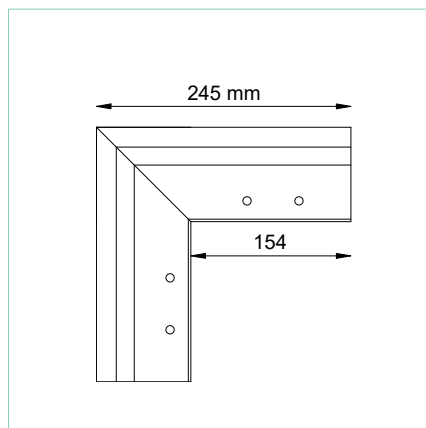

A100 90 PARAPET TRIM EXTERNAL CORNER

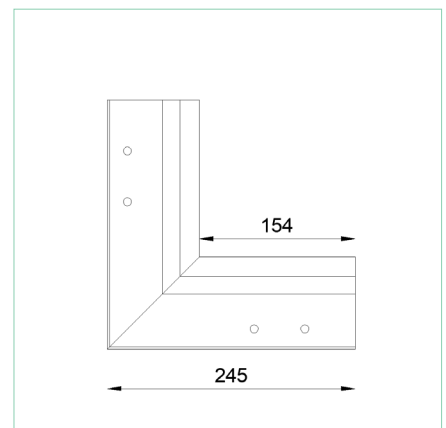

A100 90 PARAPET TRIM INTERNAL CORNER

# Renoplast A100

## PARAPET EDGE TRIM

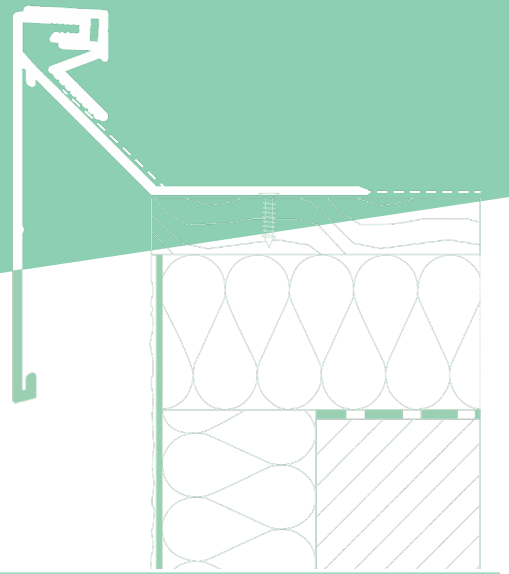

### INSTALLATION EXAMPLE

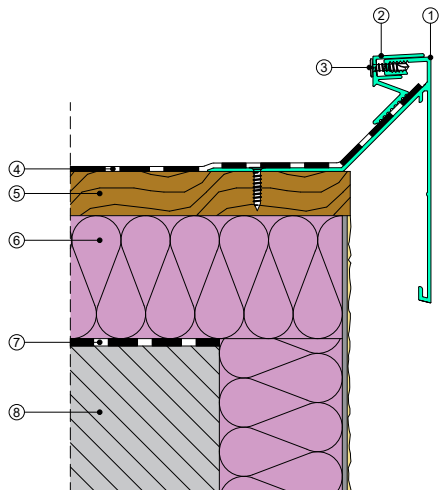

1. A100 parapet edge trim
2. A20 termination bar
3. Self-drilling screw
4. Waterproof barrier (e.g., EPDM)
5. OSB
6. Insulation
7. Vapour control layer
8. Parapet wall

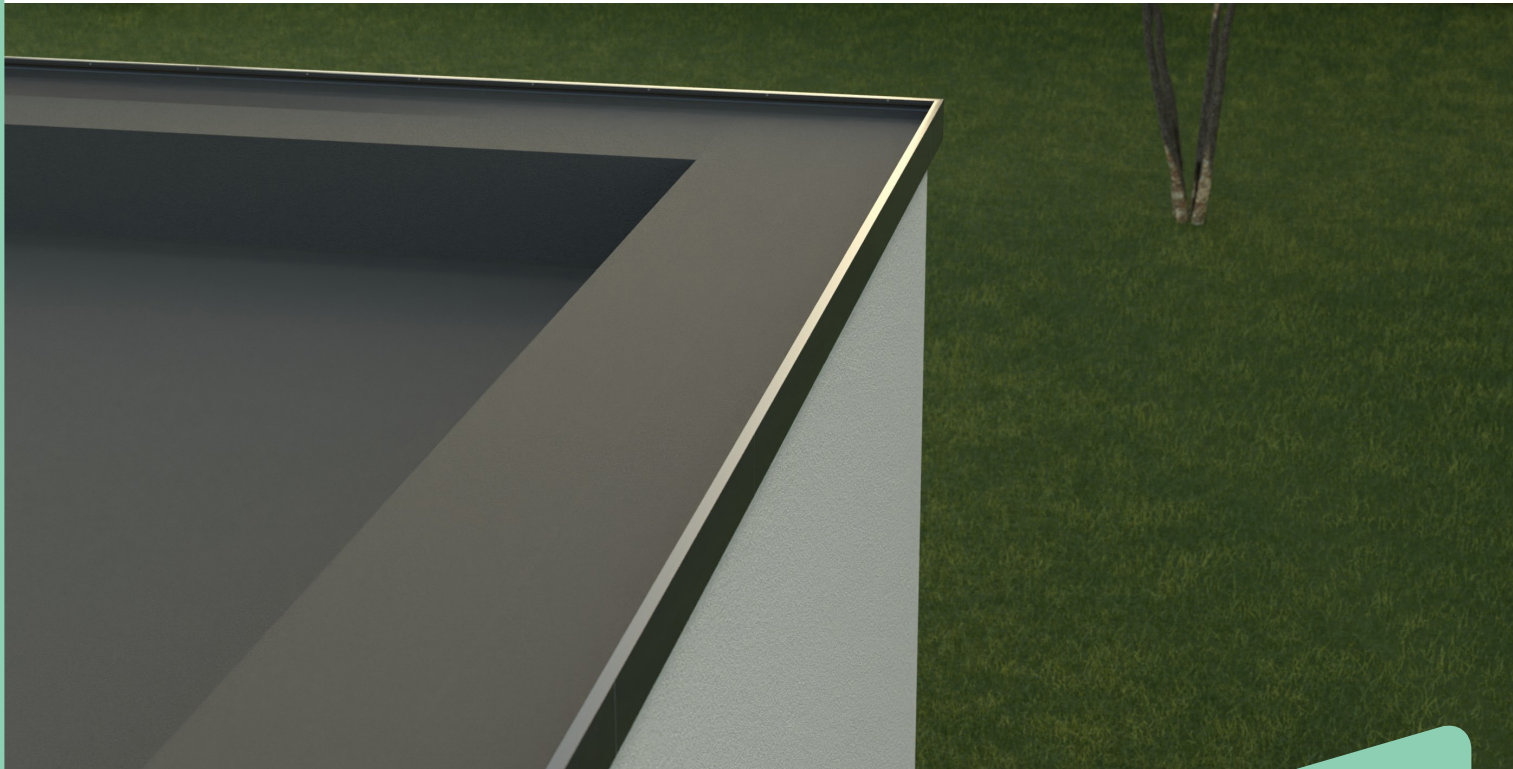

#### Notes:

Edition: 6.05.2026. This product brochure supersedes all previous editions. It gives recommendations for standard application conditions only, and thus shall not be used in place of installation drawings. Suitability of our products for particular conditions should be verified by the contractor. The actual product specifications may vary slightly due to allowable process or tool dimension changes. Any materials used in combination with Renoplast products must be obtained from reputable sources. Our liability for any omissions or inaccuracies of the data given in this brochure is limited to gross disinformation and/or negligence.

Renoplast

RENOPLAST Sp. z o.o.  
phone: +48 697 635 580  
office@renoplast.pl  
www.renoplast.pl/en

