

W20R drip edge is part of UNIWERSAL W20R edging system used with pedestal flooring consisting of 20 mm porcelain pavers supported on RENOPAD PRO adjustable pedestals placed on EPDM membrane waterproof barrier. Fascia is finished with 20 mm thick porcelain panels. Allows attachment of Renoplast RK65 aluminium gutter system.

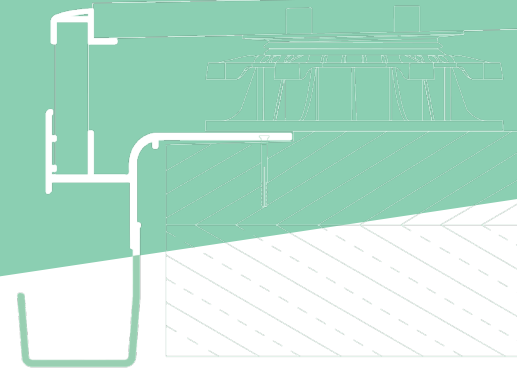

KEY FEATURES

- effective drainage of moisture from the waterproof barrier through large drain and overflow holes firm
- firm restraint for the paving
- long-term durability and full corrosion resistance
- offers neat eaves finishing with adjacent paving raised up to 20 cm
- allows attachment of Renoplast RK65 aluminium gutter system

TECHNICAL DATA

BODY	AW 6060 aluminium alloy
WEIGHT	W20R approx. 1590 g/m (linear meter), W20Z approx. 310 g/m (linear meter)
COATING SYSTEM	0.6 - 1.2 g/m ² conversion coating, and min. 60 µm polyester powder coating

INSTALLATION TOOLS

You will need the following tools: folding ruler, spirit level, knife, electric drill, hand-held mixer, steel plastering trowel, string line, pencil, spatula, metal handsaw or circular saw. Circular saw should be equipped with an aluminium cutting blade to cut without damaging the coating.

AUXILIARY COMPONENTS

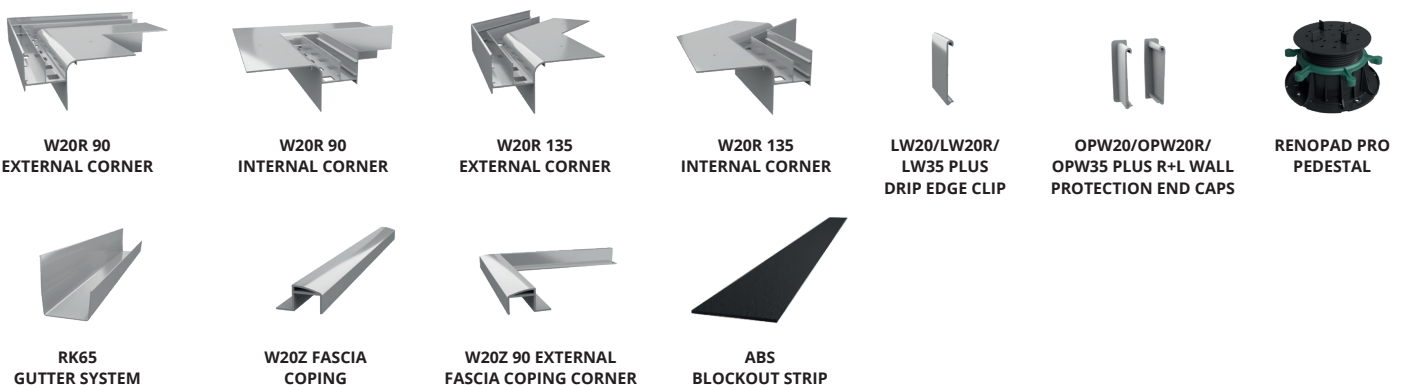

BASE

The base must be sound, level and clean. Screeds should be of min. C20 strength and should cure for 28 days. A recess, 3mm deep by 80 mm wide, should be formed around the floor perimeter to allow setting the drip edge flush with the screed top surface. This recess may be blocked out with blockout strip (supplied on request) in the case of new screed layers. In existing screeds the recess should be milled to the required depth and width (80 mm by 3 mm).

AMBIENT CONDITIONS DURING INSTALLATION

Ambient conditions should be as typically required for waterproofing and installation work.

W20R drip edge is part of UNIWERSAL W20R edging system used with pedestal flooring consisting of 20 mm porcelain pavers supported on RENOPAD PRO adjustable pedestals placed on EPDM membrane waterproof barrier. Fascia is finished with 20 mm thick porcelain panels. Allows attachment of Renoplast RK65 aluminium gutter system.

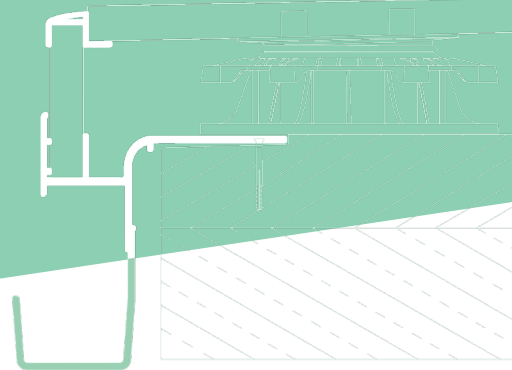

COLOURS

Standard colours: RAL 7037 dusty grey, RAL 7024 graphite grey, RAL 8019 grey brown. Other colours from RAL Classic chart are available on request.

INSTALLATION

The drip edges should be set on sealing slurry or flexible sealant and secured in place with plastic plugs. Follow the installation guide available at: <https://www.renoplast.pl/download>.

SEE PRODUCT →



INSTALLATION GUIDELINES

Protect the paint coat from damage during installation. Reject any damaged components. Any dirt should be removed from the surfaces using water and non-abrasive cloth. Wet materials, such as sealing slurry or tile adhesive should be removed from the outer surfaces before drying. The manufacturer shall not be liable for any damage resulting from product misuse or using inadequate auxiliary materials or tools. All work must be in compliance with construction plans, product data sheet, relevant standards, good construction practice and safety requirements.

MAINTENANCE GUIDELINES

For cleaning use clean water with some detergent. Do not use highly acidic or high alkaline cleaners or surfactants, which may react with aluminium. Do not use organic solvents containing esters, ketones, aromatic compounds, glycol esters, chlorinated hydrocarbons, etc. After cleaning rinse the surfaces with cold clean water. In winter do not use salt or other de-icing chemicals. We recommend to check the condition of the relevant terrace, patio and balcony components every six months. Immediately remove any discovered defects.

DIMENSIONS

CROSS-SECTIONS:

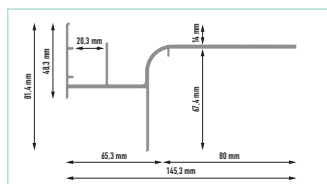

W20R DRIP EDGE

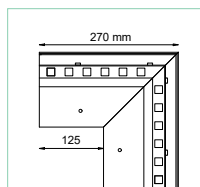

W20R 90 EXTERNAL CORNER

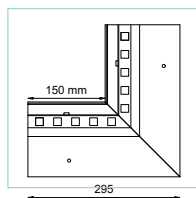

W20R 90 INTERNAL CORNER

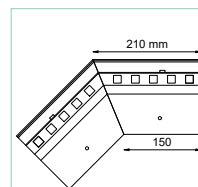

W20R 135 EXTERNAL CORNER

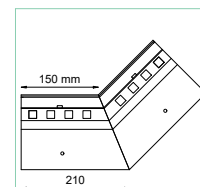

W20R 135 INTERNAL CORNER

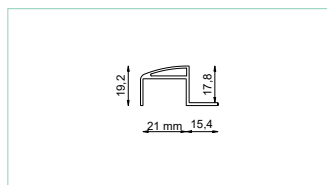

W20Z FASCIA COPING

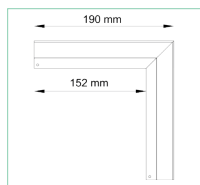

W20Z 90 EXTERNAL FASCIA COPING CORNER

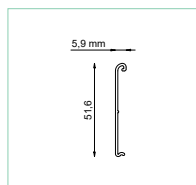

LW20/LW20R/LW35 PLUS DRIP EDGE CLIP

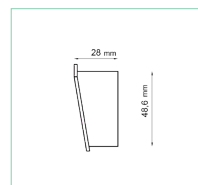

OPW20/OPW20R/OPW35 PLUS R+L WALL PROTECTION END CAPS

W20R drip edge is part of UNIWERSAL W20R edging system used with pedestal flooring consisting of 20 mm porcelain pavers supported on RENOPAD PRO adjustable pedestals placed on EPDM membrane waterproof barrier. Fascia is finished with 20 mm thick porcelain panels. Allows attachment of Renoplast RK65 aluminium gutter system.

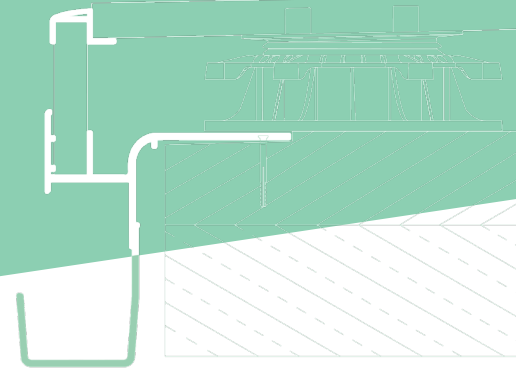
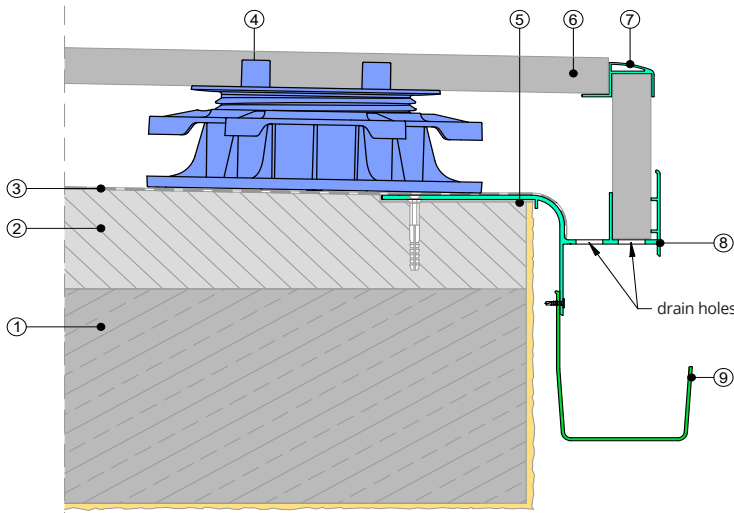
**INSTALLATION EXAMPLE**

1. Structural slab
2. 1.5-2% sloping layer
3. Waterproof barrier (e.g., EPDM membrane)
4. RENOPAD PRO adjustable pedestal
5. Elastic sealant adhesive
6. Paver
7. W20Z fascia coping
8. W20R drip edge
9. RK65 gutter

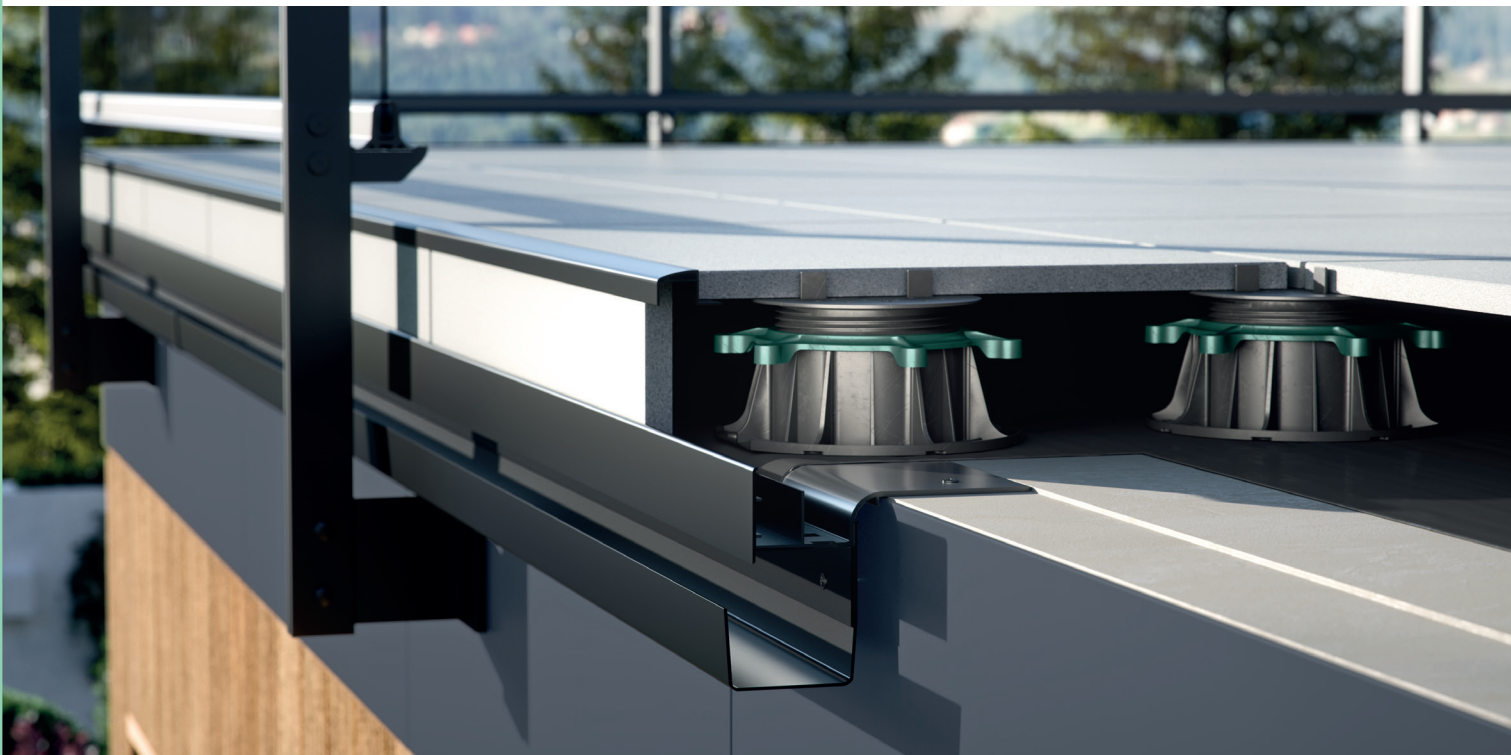
**Notes:**

Edition: 4.05.2026. This product brochure supersedes all previous editions. It gives recommendations for standard application conditions only, and thus shall not be used in place of installation drawings. Suitability of our products for particular conditions should be verified by the contractor. The actual product specifications may vary slightly due to allowable process or tool dimension changes. Any materials used in combination with Renoplast products must be obtained from reputable sources. Our liability for any omissions or inaccuracies of the data given in this brochure is limited to gross disinformation and/or negligence.

