

SMART are fixed-height pedestals used to support terrace, patio or balcony flooring pavers. They are compatible with Renoplast drip edges: W30, W30R PLUS, W35 PLUS, W60, W63.

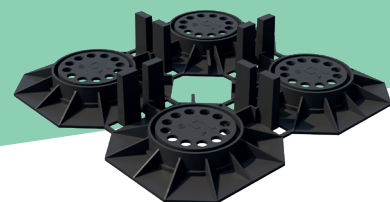

KEY FEATURES

- very high compressive strength of min. 18,0 kN
- very stable support for floor pavers
- higher efficiency of material use owing to modular construction
- 0.5 mm, 1.0 mm, 2.0 mm, 3.0 mm levelling discs to accommodate small level differences
- can be stacked to extend height

TECHNICAL DATA

BODY	polypropylene
HEIGHT	12 mm
PAVER SPACING:	2 mm or 5 mm

INSTALLATION TOOLS

You will need the following tools: folding ruler, knife, spirit level, tile suction cup.

AUXILIARY COMPONENTS



0.5 MM
LEVELLING DISC



1.0 MM
LEVELLING DISC



2.0 MM
LEVELLING DISC



3.0 MM
LEVELLING DISC

BASE

Cement-bound or other robust material.

INSTALLATION

SMART pedestals are placed on the waterproof barrier. Follow the installation guide available at: <https://www.renoplast.pl/download>.

SEE PRODUCT →



Renoplast SMART

SMART FIXED HEIGHT PEDESTALS

SMART are fixed-height pedestals used to support terrace, patio or balcony flooring pavers. They are compatible with Renoplast drip edges: W30, W30R PLUS, W35 PLUS, W60, W63.

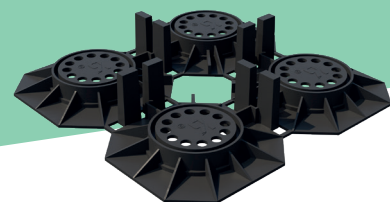

INSTALLATION GUIDELINES

Before installation read the product brochures or any other relevant guidelines relating to pedestal flooring installation, paying particular attention to support spacing requirements.

MAINTENANCE GUIDELINES

SMART pedestals are suitable for balcony, terrace, patio floors and other areas with max. specified live load of 3,5 kN/m².

DIMENSIONS

SMART pedestal with 2 mm paver spacing

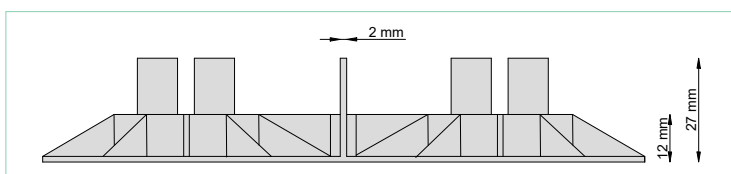

SMART pedestal with 5 mm paver spacing

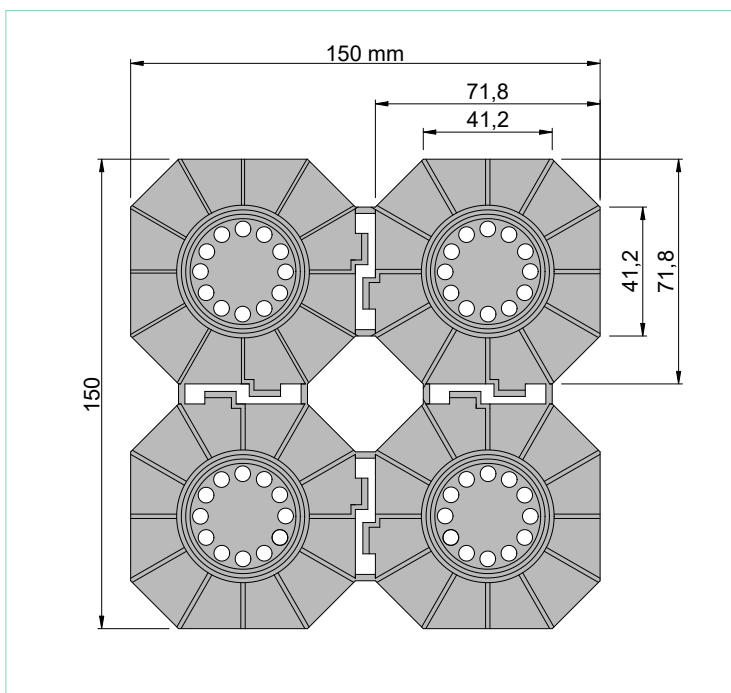
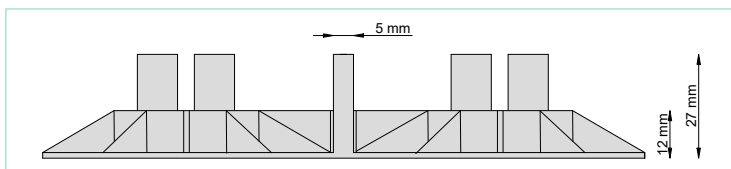

Renoplast SMART

SMART FIXED HEIGHT PEDESTALS

SMART are fixed-height pedestals used to support terrace, patio or balcony flooring pavers. They are compatible with Renoplast drip edges: W30, W30R PLUS, W35 PLUS, W60, W63.

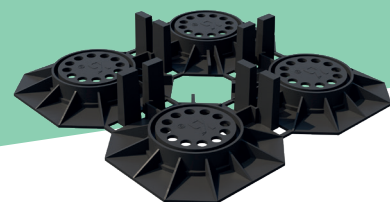

INSTALLATION EXAMPLE

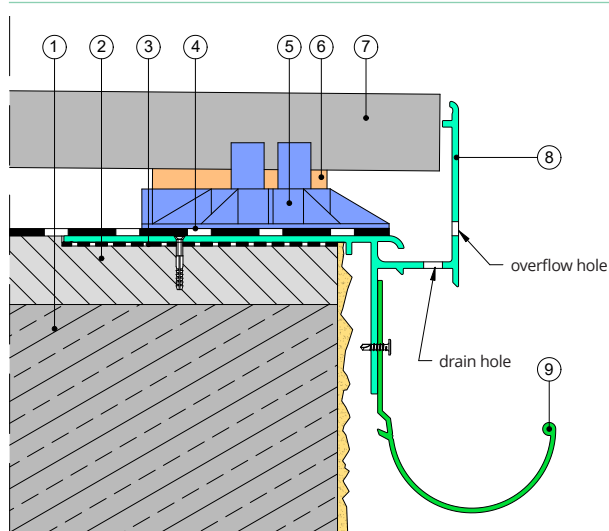

1. Structural slab
2. 1.5 - 2% sloping layer
3. Polyurethane or other suitable sealant
4. Waterproof barrier (e.g., EPDM)
5. SMART pedestal
6. Levelling disc
7. Paver
8. W35 PLUS drip edge
9. R50 gutter

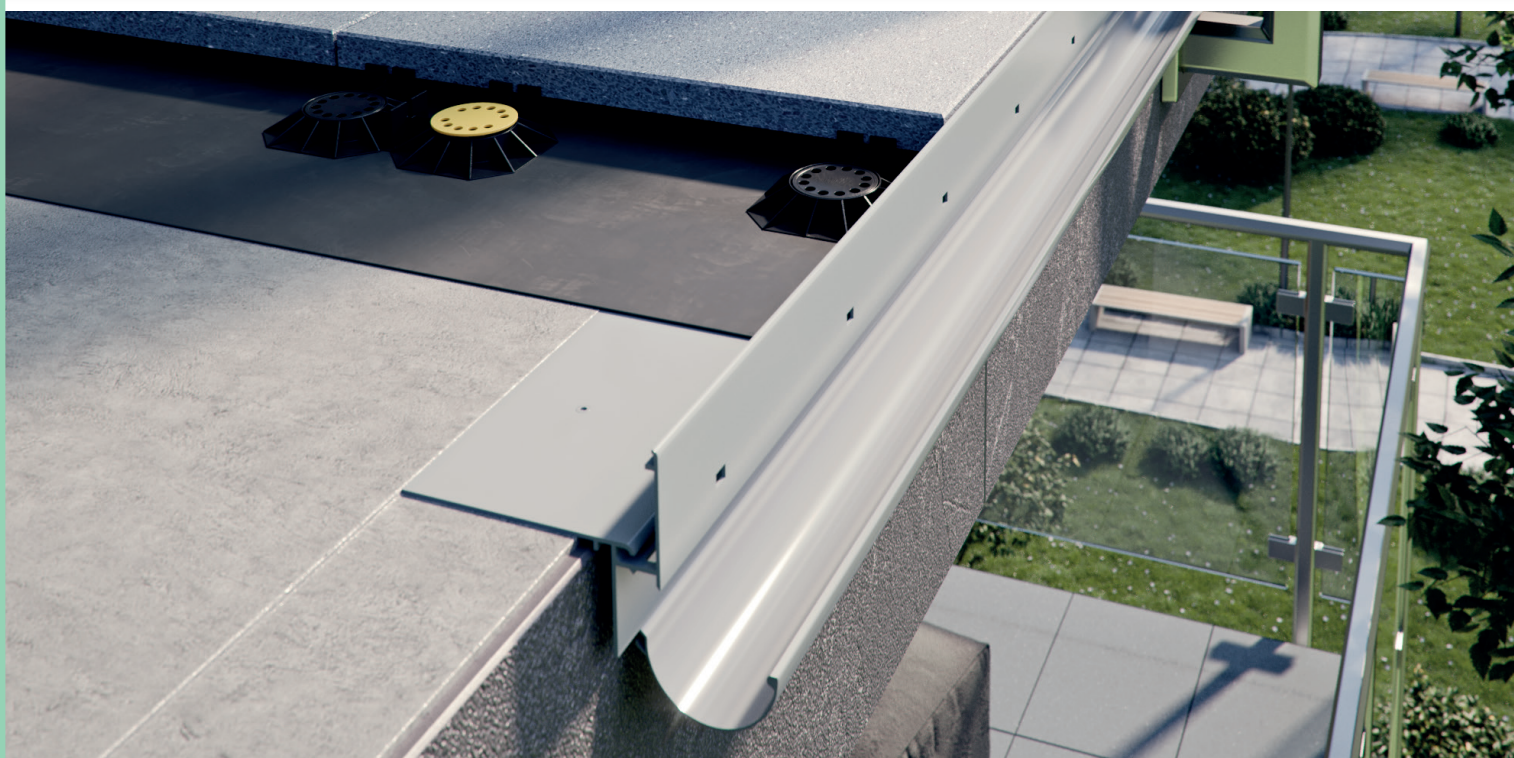

Notes:

Edition: 4.05.2026. This product brochure supersedes all previous editions. It gives recommendations for standard application conditions only, and thus shall not be used in place of installation drawings. Suitability of our products for particular conditions should be verified by the contractor. The actual product specifications may vary slightly due to allowable process or tool dimension changes. Any materials used in combination with Renoplast products must be obtained from reputable sources. Our liability for any omissions or inaccuracies of the data given in this brochure is limited to gross disinformation and/or negligence.

Renoplast

RENOPLAST Sp. z o.o.
phone: +48 697 635 580
office@renoplast.pl
www.renoplast.pl/en

